

energy DUO RF  
EDX

**Compatible**

- FENCE WiFi GATEWAY GW100
- FENCE GATEWAY GW10

**230V ~ / 12V**

- > fencee **energy DUO RF EDX80**
- > fencee **energy DUO RF EDX100**
- > fencee **energy DUO RF EDX120**
- > fencee **energy DUO RF EDX150**

	STORED ENERGY	OUTPUT ENERGY	OUTPUT VOLTAGE	OUTPUT VOLTAGE 500 Ω	SWITCHING ON / OFF				
fencee <b>energy DUO RF EDX80</b>	11 J	8 J	10 000 V	7000 V	✓	230 km	80 km	17 km	8 km
fencee <b>energy DUO RF EDX100</b>	13 J	10 J	10 000 V	7000 V	✓	300 km	90 km	22 km	10 km
fencee <b>energy DUO RF EDX120</b>	15 J	12 J	10 500 V	7500 V	✓	320 km	100 km	25 km	13 km
fencee <b>energy DUO RF EDX150</b>	20 J	15 J	10 500 V	7500 V	✓	350 km	120 km	28 km	16 km

[www.fencee.eu](http://www.fencee.eu)

+420 730 893 828



**PHONE CONTROL**

Control and monitor through mobile application



**fencee Cloud**  
FREE APP



# DECLARATION OF CONFORMITY

## Manufacturer:

VNT electronics s.r.o.  
Dvorská 605, 563 01 Lanškroun  
Company ID-No.: 64793826

declares that the below listed products:

## ENERGIZER FOR ELECTRIC FENCES

fencee **energy DUO RF EDX80**, fencee **energy DUO RF EDX100**  
fencee **energy DUO RF EDX120**, fencee **energy DUO RF EDX150**

are in accordance with requirements of standards  
and regulations relevant for given type of devices:

**2014/35/EU**  
**2014/30/EU**



Products are safe under condition of their conventional use  
in accordance with instructions for use. Declaration  
of conformity is issued pursuant to these materials:

**Test Report No.:**  
**39 057**

Issued by accredited **Státní zkušebnou strojů a.s.**,  
Třanovského 622/11, 163 00, Praha 6.

This declaration is issued at explicit responsibility of the manufacturer.

In Lanškroun January 29th. 2021

Ing. Jan Horák  
Executive Head of the Company  
Phone: +420 730 893 828  
info@fencee.eu  
**www.fencee.eu**



fencee



Thank you for purchasing the product fence➊  
of the company **VNT electronics s.r.o.**  
The equipment conforms to safety regulations in accordance with  
valid legislation as well as relevant EU (CE) regulations.

**We also ask you to read these instructions for use before using the device carefully  
and to keep it for possible application in the future.**

**Electric fence must be constructed so that persons are protected against  
unintentional contact with pulses conductors under normal operating conditions.**

From the point of view of legislation relate to the fences especially the standard  
**2014/35/EU - 2014/30/EU** and  
**R&TTE EN300-220 a EN 61000-6-3:2007 + A1:2011**

## 1. CONTENT

<b>1</b>	Content .....	<b>3</b>
<b>2</b>	Important recommendations .....	<b>4</b>
<b>3</b>	Package contents .....	<b>4</b>
<b>4</b>	Function electric fence .....	<b>5</b>
<b>5</b>	Introduction .....	<b>6</b>
	5.1 Remote control .....	<b>6</b>
	5.2 Enerizers EDX with power output higher than 5 J .....	<b>7</b>
	5.3 List of main advantages .....	<b>8</b>
<b>6</b>	Product description .....	<b>9</b>
<b>7</b>	Ready to use .....	<b>10</b>
<b>8</b>	Control .....	<b>14</b>
<b>9</b>	Explanation of LED indicating lights and bargraph indicator .....	<b>15</b>
<b>10</b>	Display .....	<b>16</b>
	10.1 Main screen .....	<b>16</b>
	10.2 Informative screen .....	<b>18</b>
	10.3 Setting screen .....	<b>19</b>
<b>11</b>	Safety guidelines .....	<b>22</b>
<b>12</b>	Troubleshooting .....	<b>25</b>
<b>13</b>	Guarantee .....	<b>26</b>
<b>14</b>	Technical parameters .....	<b>27</b>

## 2. IMPORTANT RECOMMENDATIONS



**We recommend that this manual is read thoroughly and fully understood before using the device and that it is retained for future reference!**

- The energizer will provide better protection for your animals and land. Local conditions and surroundings always affect the device function and for that reason the manufacturer is not able to guarantee full protection against damage to the enclosure fence.
- Only use the original 14 V / 2 A adapter to supply the generator. The supply voltage must not exceed 16 V. Controller must be used if the solar panel is used as the generator must not be connected directly to the panel.
- Switch off the energizer before carrying out any work on the electric enclosure fence.
- Read thoroughly the Safety Guidelines paragraph.
- Strictly observe all safety guidelines during installation work.
- Do not connect the device on one enclosure fence to another appliance. Damage to all connected devices and appliances may occur in the event of lightning strike.
- The device may only be repaired by the manufacturer's qualified personnel.
- Please dispose all waste in accordance with your country's code of practice.
- Do not let the unconnected battery cable hang freely as the short circuit and the consequent destruction of the generator may take place.
- **The displayed output voltage tolerance is  $\pm 10\%$ .**

## 3. PACKAGE CONTENTS

- Energizer fencee **energy DUORF EDX**
- Earthing cable 150 cm
- Connecting cable to the fence system 100 cm
- RF antenna
- 14 V / 2 A power supply adapter for mains connection
- Battery cable 170 cm
- fencee warning sign
- 2 installation self-tapping screws and rawlplugs
- User Manual

## 4. FUNCTION ELECTRIC FENCE

### How the electric fence works

Electric fence system consist from the energizer and fencing marked with posts and conductors. The energizer creates regular high-voltage impulses that generate a voltage between the conducting material and the ground. When an animal (or a person, vegetation or similar) creates a connection between the ground and the conducting material, the circuit is completed.

Generated impulses are unpleasant, but not dangerous to people or animals as they only act for a short period of time and results in the desired deterrent effect. The impulse lasts for a matter of milliseconds. These fences serve not only to enclose an area, but also act as a deterrent e.g. to protect against wild boars.

### Benefits of electric fence systems:

- Electric fences are long-lasting, simple to put up and great value for money compared with normal fences.
- It is easy to assembly and flexible for using.
- Designed for guarding and protecting different animals.
- Compared to other fences, such as barbed wire, it does not cause any damage to the animals.

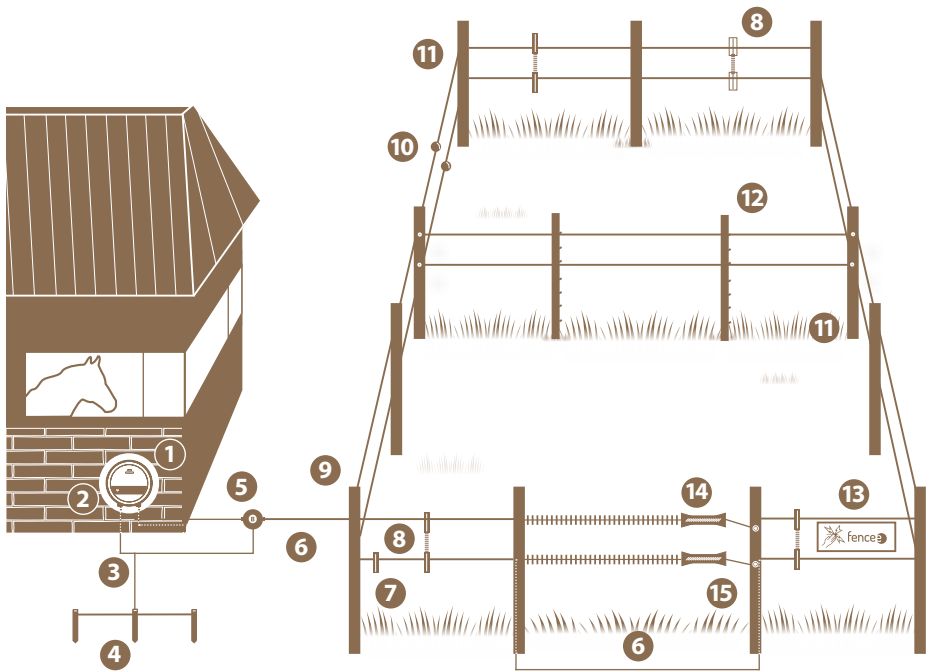

1	Energizer fence
2	ON / OFF button on energizer
3	Earthing cable
4	Anticorrosive earthing rod
5	Lightning diverter

6	High-voltage connecting cable
7	Conductor
8	Line connector
9	Fixed post
10	Tensioner

11	Insulators
12	Flexible post
13	Warning sign
14	Gate
15	Insulator of gate

## 5. INTRODUCTION

Powerful energizers **energy DUO RF EDX** are suitable for long and densely overgrown fence system, where it is essential to ensure maximum efficiency and reliability. Owing to their performance, they are able to overcome even densely overgrown fence systems and provide required voltage along the entire fence system length. The integrated microprocessor fully controls the operation and ensures optimal performance taking into account the condition of the fence system and the current situation.

Energizer **energy DUO RF EDX** may be either powered from 230 V mains using 14 V power supply adapter (include in the package contents) or appropriate 12 V battery.

The fence load is continuously measured during the fence system operation. The energizers energy DUO RF EDX power output is then automatically adjusted to keep the required output voltage in the widest possible load range. This control significantly aids in saving energy when using quality fence system with a low load. It also optimises energy consumption to maintain adequately high fence system voltage, which is, for example, overgrown with grass (high load).

LED indicator lights and BARGRAPH on the front of the energizer show the power supply status and fence system voltage and also signal any potential faults on the fence.

### 5.1 Remote control

Energizers **energy DUO RF EDX** may be remotely controlled using RF technology and Cloud application; it is also essential to install FENCE WiFi GATEWAY GW100, which centrally controls and monitors all connected devices. The EDX energizer is paired with the FENCE WiFi GATEWAY GW100 thus the energizer may be remotely controlled using the fencee Cloud application from mobile phone or via web interface.

#### UP-TO-DATE INFORMATION

Online up-to-date information on all devices.

#### CONTROL FROM PHONE

Control and monitor using mobile application.

#### ALARM SIGNALLING

Immediate warning sent to the phone and e-mail relating to the problem.



#### SAVING TIME

Using remote control means that walk around the fence system is no longer required. All is monitored and controlled from the phone, web site or gateway.



**Energizers fence energy DUO RF EDX cannot be paired and controlled by remote control, which is designed only for energizers fencee power DUO RF PDX.**

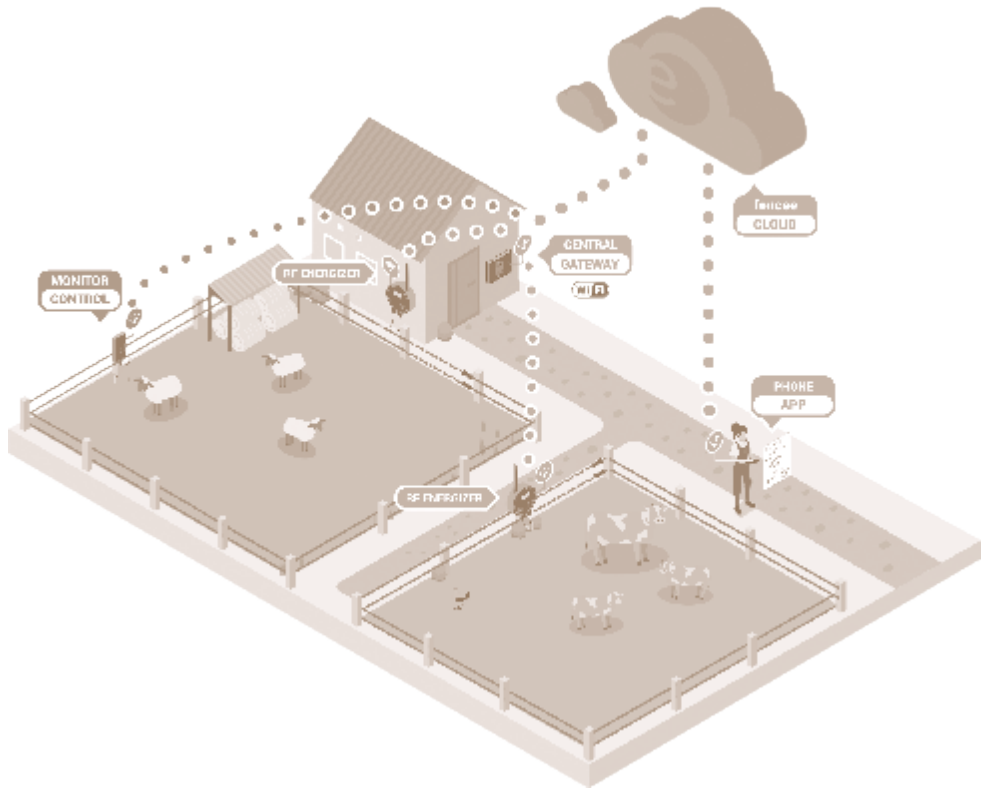

Energizers **energy DUO RF EDX** may also be remotely controlled from the FENCE GATEWAY GW10, which cannot be connected to Wi-Fi, consequently you will not be able to control using mobile phone or via web interface, only from the gateway.

## 5.2 Energizers energy DUO RF EDX with power output higher than 5 J

Standard's special requirements must be observed for energizers with power output higher than 5 J, namely time cut-off limit when the power output is increased and thus ensuring safety.

Products must be identified by mark. 

fence energizers have time cut-off limit of 50 seconds, which means that whilst the fence system is under load and its resistance drops below 500 Ohm (overgrown grass, fallen branches, etc.), the energizer will supply the maximum of 5 J for 50 s. If the fence system resistance does not increase during this time (carrying out corrective measures), the energizer will gradually increase the power output (e.g. EDX150 model up to 15 J).

Acoustic and visual warning when the fence system is suddenly under load is another feature. If the fence resistance drops abruptly during one pulse from over than 1,000 Ohm to less than 400 Ohm (fallen branches, tangled animal or human, etc.), alarm is triggered after six pulses, acoustic warning and red LED indicator light flashes. At the same time, the pulse period is shortened to 3 s. The alarm is switched off after increasing the fence resistance to more than 600 Ohm or after the time limit of 10 min. Both functions are independent and separate.

### 5.3 List of main advantages



#### **Control from phone**

Control and monitor using the fencee Cloud mobile application.



#### **Up-to-date information**

Online up-to-date information on all devices.



#### **Alarm signalling**

Immediate problem alert sent to the phone and e-mail.



#### **Cloud connection**

Using FENCE WiFi GATEWAY GW100.



#### **Combined power supply**

Power supply is either from 230 V mains or standard 12 V battery, which may also be used as the backup power supply.



#### **SIM card is not required**

No additional equipment operating costs.



#### **LCD display**

Large graphic LCD display that shows all important information.



#### **Measuring earthing**

Green terminal is used for measuring the quality of earthing.



#### **Reduced power**

Yellow output for reduced power output.



#### **Power switching**

Manual switching between the high and low power output; option for reducing demand on the battery.



#### **LED Bargraph**

Provides visual information on fence system status.



#### **Battery management**

Battery status monitoring and management.



#### **Control push buttons**

Easy and simple operation.





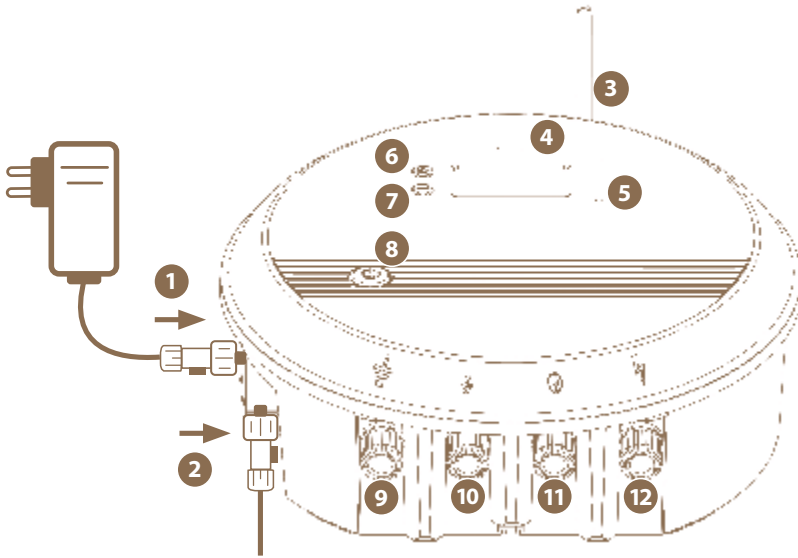

## 6. PRODUCT DESCRIPTION



1	Waterproof connector for connecting 14 V / 2 A adapter
2	Waterproof connector for connecting 12 V battery
3	SMA connector and RF antenna
4	Energizer connection monitoring and status indication shown on LED display
5	BARGRAPH shows fence system voltage
6	Push button for selecting particular display
7	Push button used for confirming / Changing values
8	ON / OFF button
9	Earthing (black)
10	Connection for measuring the quality of earthing (green)
11	Connection to fence system with reduced power (yellow)
12	Connection to fence system (red)

### Meaning of displayed symbols

-  Earthing connection for connecting to your earthing system.
-  Full voltage fence system connection for connecting to your fence system.
-  Reduced power fence system connection.
-  Connection for measuring the quality of earthing.

## 7. READY TO USE

### Choose a place suitable for installation of energizer.

- where you can achieve a good earthing.
- which is distant enough from children and animals
- where energizer is well accessible.
- where permanent water stream is avoided.

To mount energizer on wall, use attached screws, on which you can hang the energizer easily.

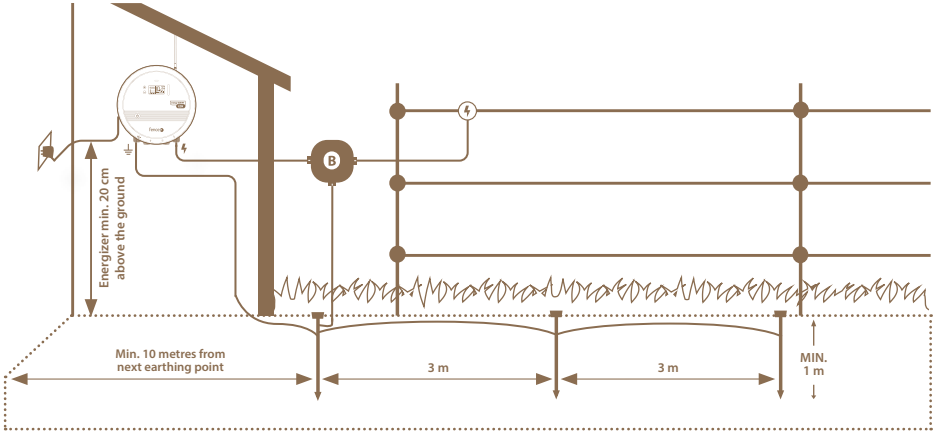

### Assembly of energizer by using DIN rail

Energizer can be easily and practically mounted by using DIN rail and mounting bracket. Set for assembly on DIN rail can be ordered as separate accessories.

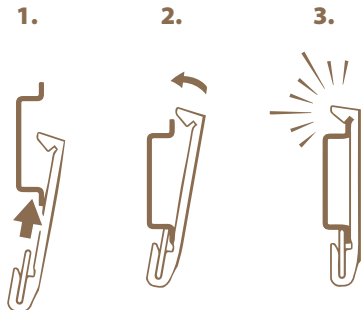
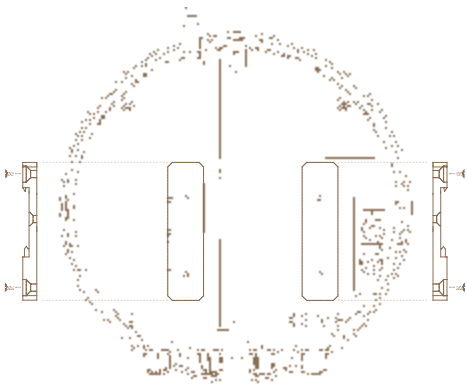



- Energizers must be installed in a dry place.
- Never put energizer on ground – in moist or wet environment.
- Fasten energizer by means of hanging screw or DIN rail with mounting bracket in vertical position – at least 20 cm above ground.
- Never expose energizer to continuous water stream.

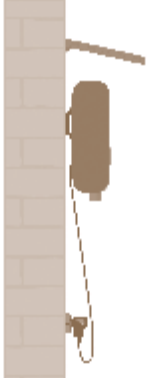

**VERTICAL ON THE WALL  
IDEALLY WITH A CANOPY**

We recommend mounting on  
DIN rail 80 mm (Art.No. 8043)



**NEVER EXPOSE TO A  
CONTINUOUS STREAM  
OF WATER!**

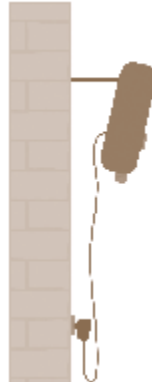

**NEGATIVE  
ANGLE**



**ON THE GROUND - IN A PUDDLE**



**ON THE GROUND - UPSIDE DOWN**

## Earthing

**Correct earthing is very important because total function of the fence system is dependent on it!**

Beat earthing rod with corrosion protection into ground completely at place with maximum and permanent humidity. On dry pieces of land or in case of soils with lower electric conductivity, use one or several supplementary earthing rods (with length of minimum of 1 m) and place them at distance of approximately 3 metres from each other.

Exceptions are fence system powered by battery energizer or working with low output. Here minimum length of earthing rod of 50 cm is recommended. Distance of at least 10 metres must be between earthing rod of fence system and another earthing system, for example earthing of a house, protective earthing of electric supply system or earthing of violation alarm.

Do not connect the energizer to already existing earthing.

## Antenna installation

Screw the RF antenna onto the SMA connector.

## Connecting connectors

Models fence **energy DUO RF EDX** have two waterproof input connectors; upper one for adapter connection and lower one for battery connection. Connectors may be wrongly connected thus always make sure that the correct connections taken place. This design has preference for connecting to the mains voltage with the option of connecting to the battery, as a backup power supply in the event of power failure. Running the energizer for a long time just from the battery is not desirable due to the higher energy consumption and low capacity of conventional batteries.

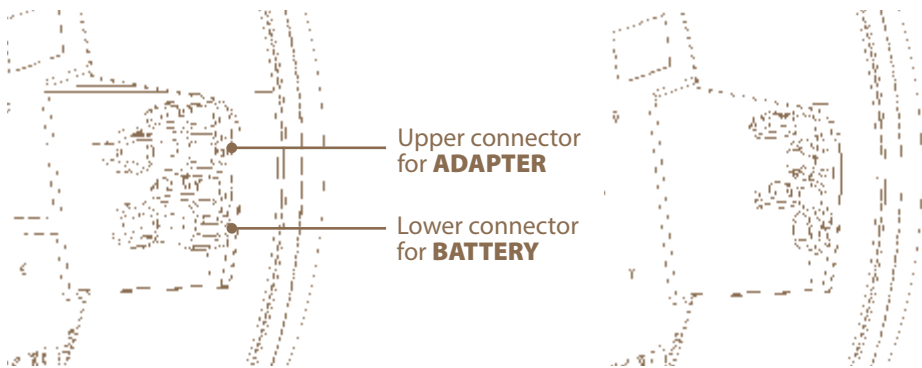

**If one of the connectors is not used then the connector cover must be screwed in to keep the connector watertight.**

**If the the adapter and battery are connected to wrong connectors, charging and the low battery indication will not work and the battery will not be discharging.**

## Connecting output

 Connect the **black earthing output** to the earthing rod using earthing cable.

 Connect the **red output** to the fence system using the connecting cable.

 **Yellow output** is intended for connecting fence system where we always require reduced energy in order that animals receive weaker, approximately half strength impulse; this relates to fence system for younger and smaller animals (foals, calves). It is also connected separately to the larger fence system lower wire, where vegetation is expected to be dense with technical measures to prevent losses, namely voltage leakage to the ground as it is usual in standard connections thus the energizer power output is not reduced. The other wires connected to the red output are powered separately at full voltage.

 **Green output** is intended for measuring the quality of earthing to find out whether the existing earthing is satisfactory or requires upgrading due to the location, e.g. adding another earthing rod, irrigate it or repair connections. It is always required to install measuring electrode located 10 m from the energizer earthing point. Use non-corroding well conducting rod at least 20 cm long for the measuring electrode. Connect high voltage cable to the green energizer connection.

It is also important what fence system impedance the energizer measures. If the energizer shows impedance of 500 Ohm or lower, i.e. long or overgrown fence system then there is no need to install anything else and the earthing check works automatically. Check the ground voltage on the energizer according to the below table.

If the fence system impedance is higher than 500 Ohm, i.e. quality fence not subjected to load, then it is required to short-circuit the fence system to enable the measurement and thus determine the quality of earthing. To carry out short-circuiting, the overhead fence system wire is earthed at a location of at least 50 m from the energizer. Use good quality earthing rod, hammer it into the ground and connect it to the wire, subsequently check the ground voltage on the energizer according to the following table.

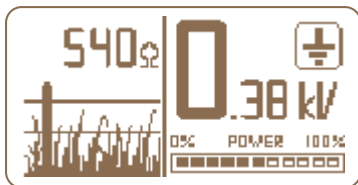

Ground voltage shown on the energizer display	Status
0 to 0,20 kV	OK
0,20 to 0,50 kV	Check earthing; add another earthing rod as a precaution
> 0,5 kV	Carry out repairs or add earthing rod

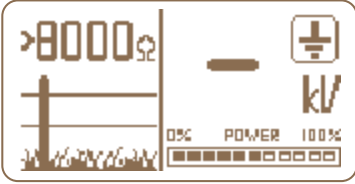

If a dash is displayed on the energizer display next to measuring the quality of earthing symbol it indicates either that the measuring electrode is not connected to the green output or that the fence system wire is not short-circuited (if fence system impedance is higher than 500 Ohm).

## 8. CONTROL

### ON / OFF AND POWER OUTPUT SWITCHING PUSH BUTTON

As with DUO PD power models, large control push button is used for basic control. The ON / OFF switch push button has extended functionality, which is used for switching the energizer power output. After switching off and then switching on again, the energizer remembers the last set power output.

#### ENERGIZER IS SWITCHED OFF; BY PRESSING PUSH BUTTON:



Long press (>2 s) → **Energizer is switched on**

Short press → **No response**

#### ENERGIZER IS SWITCHED ON; BY PRESSING PUSH BUTTON:



Long press (>2 s) → **Manual switching between the high and low power output (approximately 50%)**. User selectable; when, for example, it is used for more sensitive animals or to reduce demand on battery, if required. The low power output is always limited to the maximum of 5 J.

Short press → **Energizer is put into the Standby Mode**

#### ENERGIZER IS IN STANDBY MODE; BY PRESSING PUSH BUTTON:

Short press → **Energizer is fully switched off**



Long press (>2 s) → **Energizer is switched on**

Long press (>5 s) → **Switches to the Pairing Mode** (described in paragraph relating to Pairing on Page 21)

## 9. EXPLANATION OF LED INDICATING LIGHTS AND BARGRAPH INDICATOR

### LED control:

BURNING / BLINKING

- **blinking** – operation on battery only
- **permanent burning** – operation with adapter

COLOR

- **blue** – operation at higher output (100%)
- **purple** – operation at lower output (c. 50%)
- **red** – it lights up when battery voltage drops below 12 V.



**A fast blinking blue indicates the pairing mode of the energizer.**

When battery voltage drops below 11,6 V, warning siren is started (beeping). When battery voltage drops below 11,4 V, energizer is switched off. Reason is protection of battery from deep discharge of the battery (battery destruction). If discharged battery and adapter are connected simultaneously, red LED is burning, until battery is charged at 12 V at least.

### BARGRAPH INDICATOR:

To indicate input voltage at fence system, **energy DUO RF EDX** models are equipped with BARGRAPH indicator. It consists of six **LEDs - 2x RED | 2x YELLOW | 2x GREEN** – ordered from left to right. BARGRAPH indicator always goes through LEDs from the first red one up to indicated position where it stops for a while.

**Indicating statuses are as follows:**



- voltage **< 3 kV** - 1x RED
- voltage **3-5 kV** - 2x RED
- voltage **5-6 kV** - 1x YELLOW
- voltage **6-7 kV** - 2x YELLOW
- voltage **7-8 kV** - 1x GREEN
- voltage **> 8 kV** - 2x GREEN



## 10. DISPLAY

In the **energy DUO RF EDX** models, an information display and two buttons for the control of this display have been added.



**SETUP** button



**CONFIRM** button

The display shows information on two different screens, which can be cycled with the **Setup** button .

Use the **Confirm** button  to change or confirm the parameters on the screen.



The **first basic screen** contains a large numeral of the selected parameter on the right, and icons indicating the energizer status appear on the left.



On the **second informative screen** is displayed the status of the fence on the left, both numerically (resistance of the fence), but also graphically with an icon of overgrown grass.

On the first and second screens, you can select between the displayed parameters using the **Confirmation** button . There are three options that repeat in a circle - output voltage [kV], battery voltage [V] and output energy [%].



**Setting screen**

For entry to setting screen hold for > 2 s **Setup** button  You can use the **Confirm** button , to access the individual settings between which you move, using the **Setup** button .

### 10.1 Basic screen

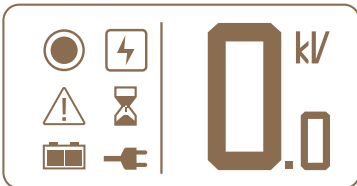

**Output voltage**



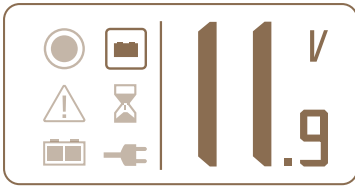

 **Battery voltage**

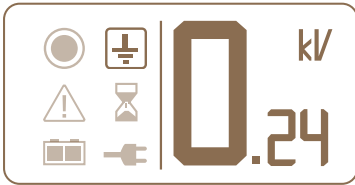

 **Measuring earthing**

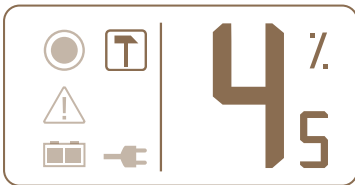

 **Output performance – Data indicating the energizer output needed in the present condition of the fence, due to its loading and losses.**

### Icons on the display:

  Icons indicating the 50% / 100% mode.

    Indicating the displayed parameter.

 Triangle indicating a warning.

 Hourglass indicates a time delay before ramping up the performance.

 Icon indicating the connection of a battery and its status.

 **Full battery** / blue - violet led → **over 12 V**

 **Half battery** / red led → **12 - 11,6 V**

 **Empty battery** / red led + siren → **11,6 - 11,4 V**  
**The energizer will shut down** → **less than 11,4 V**

 Indicates connection to the grid.

 **E1** Error message.

## Error message:



Error message E1 - error in evaluation of output voltage - may appear on the basic screen. This condition indicates that the fence system is not working properly. Energizer's power is limited to 5 J and the earthing measuring does not work. This condition can be caused by many different reasons. Therefore, in such a case, it is necessary to send the energizer to our Service Department for a specialist inspection and repair.

## 10.2 Informative screen

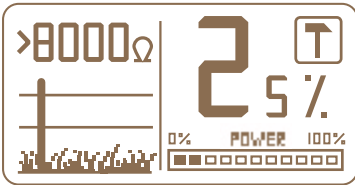

### On-screen icons indicating the load on the fence:



**>1000 ohm** – a short pen with minimum greenery

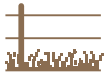

**1000 ohm** – medium pen, with mild growth of vegetation

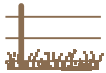

**500 ohm** – longer pen, mild growth of greenery



**300 ohm** – longer pen, medium growth of greenery or mild growth after rain



**< 300 ohm** – a pen with a dense growth of vegetation, with high power loss

### 10.3 Setting screen

For entry to setting screen hold for > 2 s **Setup** button .

You can use the confirm button to access the individual settings between which you move, using the **Setup** button .





**The following items are available:**





#### Setting

- **Alarm** - The voltage setting at which the alarm is triggered can be set in the range of 0 - 8000 V, when 0 kV the voltage alarm is off.
- **Light** - Setting the backlight time. Here you can set the values of 1 minute, 5 minutes and continuous light (ON).
- **Contrast** - Setting the display contrast in the range 90 - 150.

#### Entering the screen

1.  Enter the screen
2.  Select an item
3.  Confirm the selection
4.  Adjust the values
5.  Confirm the values

#### Leaving the screen

1.  Select the BACK item
2.  Confirm your choice
  -  You can toggle among screens

#### Back

This serves to leave the settings menu.

## Example of setting the lighting time at 1 min.

Use the settings  button to enter the settings screen



Settings screen

Use the enter  button to enter the settings

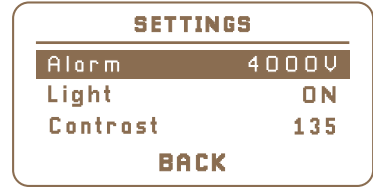

Entering the settings menu

Use the settings  button to select an item



Selection of a required item

Use the enter  button to select adjustment of an item

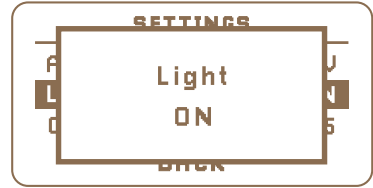

Adjustment of an item

Use the settings  button to change the value



Changing the value

Use the enter  button to confirm the given value



Changed value

Use the settings  button to go to the back item



The "back" item

Use the enter  button to leave the settings menu



Leaving the settings menu

## Pairing

If you wish to remotely control and monitor EDX energizer, then it firstly must be paired with the gateway.

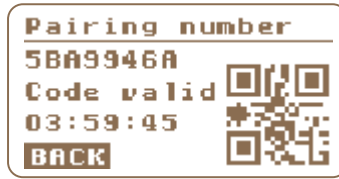

**Pair new** – It is used to pair a new device. The Pairing number screen appears and the blue LED flashes quickly. Near or far-off pairing may now be carried out.

Pairing may also be started as follows: switch off the energizer by using the ON/OFF push button in Standby Mode and hold it down for > 5 s; blue LED indicator light flashes.

Near pairing may be carried out by placing the gateway (which is also put into the Pairing Mode; refer to the Gateway Manual) RF antenna and EDX energizer antenna together.

Pairing may also be carried out remotely (EDX energizer does not have to be near the gateway). The eight-digit pairing code and Code valid are displayed on the screen. The code is used for remote pairing of the fence system with the gateway. The same code is recorded in the QR code. You may read the code by using the mobile phone camera or scan the QR code and then enter the code in the gateway for pairing.



**The pairing screen lasts 3 minutes. After three minutes, the Near Pairing Mode ends. EDX energizer automatically switches from this screen to the previous screen and blue LED indicator light stops indicating near pairing. Exit the pairing screen by pressing the BACK key.**

**Device list** - The Device list shows the type of gateway on which the fence system is paired and at the end, the beginning of the gateway MAC address. One fence may be paired on the maximum of 3 gateways.



By selecting RESET, all paired gateways may be deleted from the fence system, which also changes the fence MAC address. This means that the gateway will not be able to send or receive data from the energizer. The function is used to remove the energizer from the gateway, for example, when selling the fence, so that the original owner is not able to control the new owner's energizer via the Cloud application.

**Pairing code** - Pairing code generated in the Pair new item as the Pairing number may be repeatedly displayed in the Pairing code item with the validity period set to 4 hours.

## Factory setting

This option sets all items in the Setting Menu to the factory settings – alarm, light, contrast.

## 11. SAFETY GUIDELINES

- Install and operate the electric fence systems in such a way that they do not pose the risk of electric shock to humans, animals or disturb the environment.
- Avoid using the electric fence systems that could trap animals or people.
- One electric fence system must not be powered by two or more energizers or by independent power supply devices designated for electric fence systems of the same equipment.
- When operating two or more different electric fence systems and if they are powered by different energizers, the minimum distance between the electric fences must be 2,5 m. Use electrically non-conductive material if this distance is required to be smaller.
- Do not use barbed or razor wire or any other types of sharp-edged wire to install the electric fence system.
- Non-conductive additional fencing in which barbed or razor wire is used must be at least 150 mm from the electric fence system wire and must be earthed at regular intervals.
- All electric fence system sections installed along the public roads must be marked with warning signs attached to poles or fences at regular intervals and visible from the road.

### Warning sign

- It is of yellow colour with minimum dimensions of 100 × 200 mm
- It is either standard warning sign or contains the following Inscription on both sides: **“WARNING! ELECTRIC FENCE”**
- Letters must be at least 25 mm high and indelible
- One warning sign is included in the package contents



### Power supply and connecting cables

- Cables that are rated for voltages higher than 1 kV and are located in buildings must be effectively insulated from the building's earthing features. This may be achieved by using insulated high-voltage cables or by leaving appropriate distance between the cable and the building frame. Do not use standard electrical cables.
- Cables that are laid in the ground (soil) must be protected by solid insulator pipes or use insulated high-voltage cables designed for this purpose. Make sure that the cables will not be damaged by, for example animal hooves or tractor wheels, which can sink into the ground. Do not use standard electrical cables.
- Cables must not be placed in pipes together with other circuit, communication or data cables.

### Supply and connecting leads and electric line of fence system:

- Shall not cross above overhead power or communication lines. Crossings with overhead power lines shall be avoided wherever possible. If such a crossing cannot be avoided it shall be made underneath the power line and as nearly as possible at right angles to it.
- If are installed near an overhead power line, the clearances shall not be less than those shown

Power line voltage	Clearance
≤ 1000 V	3 metres
> 1000 ≤ 33000 V	4 metres
> 33000 V	8 metres

- If are installed near an overhead power line, their height above the ground shall not exceed 3 m. This height applies to either side of the orthogonal projection of the outermost conductors of the power line on the ground surface, for a distance of:
  - 2 m for power lines operating at a nominal voltage not exceeding 1000 V
  - 15 m for power lines operating at a nominal voltage exceeding 1000 V
- Being nearby telephone line or telephone cable, must be conducted at a distance of minimum of 2 metres.

Electric animal fences intended for deterring birds household pet containment or training animals such as cows need only be supplied from low output energizers to obtain satisfactory and safe performance.

In electrical animal fences intended for deterring birds from roosting on buildings no fence wire shall be grounded if the fence wires are not connected to metal parts. If one wire is connected with a metal part (ie a gutter) or a metal structure of the building these metal parts must be grounded. A warning sign shall be fitted to every point where persons may gain ready access to the conductors.

Where an electric animal fence crosses a public pathway, a non-electrified gate shall be incorporated in the electric animal fence at that point or a crossing by means of stiles shall be provided. At any such crossing, the adjacent electrified wires shall carry warning signs.

Avoid direct contact with fencing, especially with head, neck or upper part of body. Do not creep through the fencing or over it. For passing the fence system, use a gate or another point in installation designed for this purpose.

## Overvoltage protective equipment – lightning diverter

To prevent from damages caused by lightning, we recommend leading a circuit of fence system near to building via overvoltage protective equipment – lightning diverter fastened to outer masonry of the building by means of non-combustible materials before its connecting to energizer. This applied also for combined energizers, if they are used together with a network adapter.

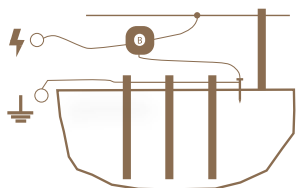

Overvoltage caused by storm can cause insulation of electric fence system. In such a case, network voltage can get into electric fence system, and serious danger to people or animals can occur.

Generally, we recommend connecting network powered electric fence system only to such supply networks that are protected with earth-leakage circuit breaker with maximum actuating current of 30 mA. In addition to that, correct installation of energizer with auxiliary discharger and choking coil is necessary, as described within these instructions. It is suitable to disconnect network supplied electric fence system from network as well as from fencing (if possible) during storm.

If a network with earth-leakage circuit-breaker was not used for purposes of supplying energizer, and the energizer was connected to the fence system or the network during storm, it is necessary to check and test it before putting it into operation again.

For this purpose, connection to network with earth-leakage circuit-breaker must be available. For purposes of testing, connect earthing output of energizer to protective conductor of the supply network and connect pin to power socket protected with earth-leakage circuit-breaker then. If energizer beats correctly and does not show any deviations from normal operation subsequently, it can be connected to fence system again. If the earth-leakage circuit-breaker however falls out when energizer is connected, you must not use it and it must be repaired professionally.

If connecting lines of this energizer are damaged, they must be replaced by manufacturer or authorized service or another qualified person so that possibility of danger is excluded. Service and repairs of these energizers must be performed by authorized persons only!

Each user of electric fence system is responsible for its operation and should perform regular checks of energizer and fence system at least once a day, depending on operating conditions

Procedure of checking:

- Visual control of energizer and fence system
- Measuring of minimum voltage of 2500 V in every place of the fence system

If installation is performed inside a building, energizer may not be operated in a room with increased risk of fire in any case (barn, shed, cattle shed). In addition to that, no combustible materials may be stored near to fence system and connectors of energizer. Installation of energizer must be made on a fire-resistant surface.

### **For stable using, use only energizers designed for that purpose!**

Do not connect battery or accumulator energizers to electric power network or devices being connected to network voltage, except for sources determined to that by the manufacturer, in any case. This energizer may not be used by persons (including children) who have limited physical, perceptive or mental abilities or do not possess sufficient experiences and knowledge, when they are not under supervision or are not trained for operating energizer by persons who are responsible for their safety. Children should be under supervision so that there is not chance that they play with the energizer.

Ensure that all connected network supplied auxiliary circuits have at least the same protection class as energizer.



## 12. TROUBLESHOOTING

In case that electric fence system does not work properly, so there are some tips for troubleshooting.

Cause	Fault removal
<b>Energizer does not work?</b>	Disconnect the device from the fence system and switch it on again! If blue or violet LED is burning and yellow or green LED is flashing on BARGRAPH indicator, then the device works properly. Otherwise, the device is damaged (contact your salesman). When using battery and accumulator devices, observe correct wiring of poles.
<b>Red LED light is blinking</b>	Battery voltage decreased below 12 V - replace the battery with a sufficiently charged one or connect adapter.
<b>Red LED light is blinking and warning siren sounds (beeping)</b>	Battery voltage decreased below 11,6 V - replace the battery with a sufficiently charged one or connect adapter.
<b>No LED signal is burning</b>	Energizer is switched off manually or battery voltage decreased below 11,4 V and energizer was switched off automatically. Reason is protection of battery from its deep discharge (and battery destruction). Replace the battery with a sufficiently charged one or connect adapter – until battery voltage reaches at least 12 V, red LED will be burning.
<b>Lead-in or short circuit of supply lines of the fence system</b>	Do not use conventional cables for supply lines. High-voltage cable is recommended.
<b>Conductor has adverse properties (thin diameter, high resistance)</b>	Use high-quality conductor with low resistance and larger diameter. Ensure high-quality correct connection of conductors.
<b>Low-quality earthing, too short earth rod, corrosion, dry soil</b>	Add next rod, moisten.
<b>Lead-in via growth near fence system</b>	Remove the growth (mow it).
<b>Conductor on ground (for example break, insufficient mechanical tension)</b>	Repair fencing, use special connectors, stretch conductor.
<b>Too long fence system. Was correct accessories used for given purpose?</b>	Use accessories suitable for given length of fence system and for animals – in case of need, consult specialized salesman.
<b>Insulator pierces, losses occur</b>	Replace defective and weather-worn insulators.
<b>Conductor is connected via knot, insufficient connection</b>	Use relevant special connectors for the conductor.
<b>Displayed error message E1</b>	Error in evaluation of output voltage. This condition indicates that the fence system is not working properly. Energizer's power is limited to 5 J and the earthing measuring does not work. It is necessary to send the energizer to our Service Department for a specialist inspection and repair.

### 13. GUARANTEE

In addition to a guarantee requested by law, we provide you with a guarantee in accordance with below listed conditions:

- Guarantee period begins on the day of its purchase. Guarantee claims are acknowledged explicitly pursuant to submission of bill or cash voucher. Guarantee repair is free of charge, or we reserve the right to deliver a device of the same value.
- Guarantee is valid in case of correct use in accordance with the instructions for use. It expires in case of interferences by unauthorized persons and in case of using spare parts of foreign origin.
- All deficiencies resulting from material defects or manufacturing defects shall be removed in manufacturer's discretion by repairing or free-of-charge replacement of the energizer.
- In case of delivering spare parts or repairing, original guarantee period is not prolonged.
- Guarantee period and address of guarantee provider can be found in attached instructions for use of given type of energizer.
- Accumulators or batteries of any type, damages due to overvoltage (caused by lightning among others) and damages due to spill-over of accumulator acid are not included in the guarantee.

**This energizer is provided with guarantee period of 3 years according to our conditions for guarantee! Safety instructions, earthing, putting into operation, care of batteries and accumulator, conditions for guarantee and possible fault sources can be found in attached instructions for use!**

## 14. TECHNICAL PARAMETERS

	energy DUORF EDX80	energy DUORF EDX100	energy DUORF EDX120	energy DUORF EDX150
POWER SUPPLY	<b>230 V ~</b> 6–11 W	<b>230 V ~</b> 6–14 W	<b>230 V ~</b> 6–17 W	<b>230 V ~</b> 6–21 W
POWER CONSUMPTION	<b>12V</b>  200–750 mA	<b>12V</b>  200–850 mA	<b>12V</b>  200–1000 mA	<b>12V</b>  200–1250 mA
INPUT ENERGY	11 J	13 J	15 J	20 J
OUTPUT ENERGY	8 J	10 J	12 J	15 J
OUTPUT VOLTAGE	10000 V	10000 V	10500 V	10500 V
OUTPUT VOLTAGE 500 Ω	7000 V	7000 V	7500 V	7500 V
LCD DISPLAY	✓	✓	✓	✓
ON / OFF	✓	✓	✓	✓
LED ON / OFF	✓	✓	✓	✓
LED IMPULS	✓	✓	✓	✓
LED LOW BATTERY VOLTAGE	✓	✓	✓	✓
LED POWER LOWER 50%	✓	✓	✓	✓
LED ERROR CHECK	✓	✓	✓	✓
LED IMPULS BARGRAPH	✓	✓	✓	✓
REDUCED POWER OUTPUT	✓	✓	✓	✓
MEASURING OF EARTHING	✓	✓	✓	✓
TIME DELAY	✓	✓	✓	✓
TEOR. MAX CEE	230 km	300 km	320 km	350 km
LOW VEGETATION	80 km	90 km	100 km	120 km
MEDIUM VEGETATION	17 km	22 km	25 km	28 km
HIGH VEGETATION	8 km	10 km	13 km	16 km
GROUNDING 1 M	4×	5×	5×	6×
EL. FENCE NETTING	22×	27×	32×	38×
DATA ENCODING	✓	✓	✓	✓
TRANSMISSION FREQUENCY	869,525 MHz	869,525 MHz	869,525 MHz	869,525 MHz
TRANSMITTING POWER	+ 22 dBm	+ 22 dBm	+ 22 dBm	+ 22 dBm
EXTERNAL ANTENNA SMA	✓	✓	✓	✓
DIN RAIL	✓	✓	✓	✓
DIAMETER	290 mm			
DEPTH	108 mm			
WEIGHT	3296 g			



# fencee

04052023

Stamp and signature of seller:

**fencee**  
Electric **fencing**

**VNT electronics s.r.o.**

Dvorska 605, 563 01 Lanskrout

Czech Republic

info@fencee.eu

+420 730 893 828

Servis: +420 730 893 827



f fencee.cz @ fenceeczech

[www.fencee.eu](http://www.fencee.eu)

[www.fenceefarm.com](http://www.fenceefarm.com)

[www.fenceecloud.com](http://www.fenceecloud.com)