

230 V~

› fencee power energy PE60



	STORED ENERGY	OUTPUT ENERGY	OUTPUT VOLTAGE	OUTPUT VOLTAGE 500 Ω	SWITCHING ON / OFF	TEOR. MAX. CEE			
fencee power energy PE60 EXTREME POWER	5,5 J	5 J	12 500 V	10 000 V	✓	800 km	70 km	25 km	10 km

www.fencee.eu
info@fencee.eu

+420 730 893 828



DECLARATION OF CONFORMITY

Manufacturer:

VNT electronics s.r.o.
Dvorská 605, 563 01 Lanškroun
IČO: 64793826

declares that the below listed products:

ENERGIZERS FOR ELECTRIC FENCES

fencee **power energy PE60**, fencee **power energy PE100**
fencee **power energy PE150**

are in accordance with requirements of standards
and regulations relevant for given type of devices:

2014/35/EU

2014/30/EU



Products are safe under condition of their conventional use
in accordance with instructions for use. Declaration
of conformity is issued pursuant to these materials

Test Report No.:

41 854

Issued by accredited **Státní zkušebnou strojů a.s.**,
Třanovského 622/11, 163 00, Praha 6.

This declaration is issued at explicit responsibility of the manufacturer.

In Lanškroun March 23th, 2023

Ing. Jan Horák
Executive Head of the Company
Tel.: +420 730 893 828
info@fencee.eu
www.fencee.eu

A handwritten signature in black ink, appearing to be 'J. Horák', written over a light blue grid background.



Thank you for purchasing the product fence of the company **VNT electronics s.r.o.**
The equipment conforms to safety regulations in accordance with
valid legislation as well as relevant EU (CE) regulations.

**We also ask you to read these instructions for use before using the device
carefully and to keep it for possible application in the future.**

Electric fence must be constructed so that persons are protected against
unintentional contact with pulses conductors under normal operating conditions.
From the point of view of legislation, especially the standard **ČSN EN 60335-2-76 ed.2**
(Electric appliances for domestic and similar purposes – Safety – Part 2-76: Special
requirement on energizers for electric fences) and norm **2014/35/EU - 2014/30/EU**.

1. CONTENT

1	Content	3
2	Important recommendations	4
3	Package contents	4
4	Function electric fence	5
5	Introduction	6
	5.1 List of main advantages	6
6	Product description	7
7	Ready to use	8
8	Control	10
9	Explanation of LED indicating lights	11
10	Safety guidelines	11
11	Troubleshooting	14
12	Guarantee	15
13	Technical parameters	15

2. IMPORTANT RECOMMENDATIONS



We recommend that this manual is read thoroughly and fully understood before using the device and that it is retained for future reference!

- The energizer will provide better protection for your animals and land. Local conditions and surroundings always affect the device function and for that reason the manufacturer is not able to guarantee full protection against damage to the fence system.
- Switch off the energizer before carrying out any work on the electric fence system.
- Read thoroughly the Safety Guidelines paragraph.
- Strictly observe all safety guidelines during installation work.
- Do not connect the device on one fence system to another appliance. Damage to all connected devices and appliances may occur in the event of lightning strike.
- The device may only be repaired by the manufacturer's qualified personnel.
- Please dispose all waste in accordance with your country's code of practice.
- Do not let the unconnected battery cable hang freely as the short circuit and the consequent destruction of the energizer may take place.

3. PACKAGE CONTENTS

- Energizer **fencee power energy PE**
- Earthing cable
- Connecting cable to the fence system
- fencee warning sign – Warning! Electric fence!
- 2 installation self-tapping screws and rawlplugs
- User Manual

4. FUNCTION ELECTRIC FENCE

How the electric fence works?

Electric fence system consist from the energizer and fencing marked with posts and conductors. The energizer creates regular high-voltage impulses that generate a voltage between the conducting material and the ground. When an animal (or a person, vegetation or similar) creates a connection between the ground and the conducting material, the circuit is completed. Generated impulses are unpleasant, but not dangerous to people or animals as they only act for a short period of time and results in the desired deterrent effect. The impulse lasts for a matter of milliseconds. These fences serve not only to enclose an area, but also act as a deterrent e.g. to protect against wild boars.

Benefits of electric fence systems:

- Electric fences are long-lasting, simple to put up and great value for money compared with normal fences.
- It is easy to assembly and flexible for using.
- Designed for guarding and protecting different animals.
- Compared to other fences, such as barbed wire, it does not cause any damage to the animals.

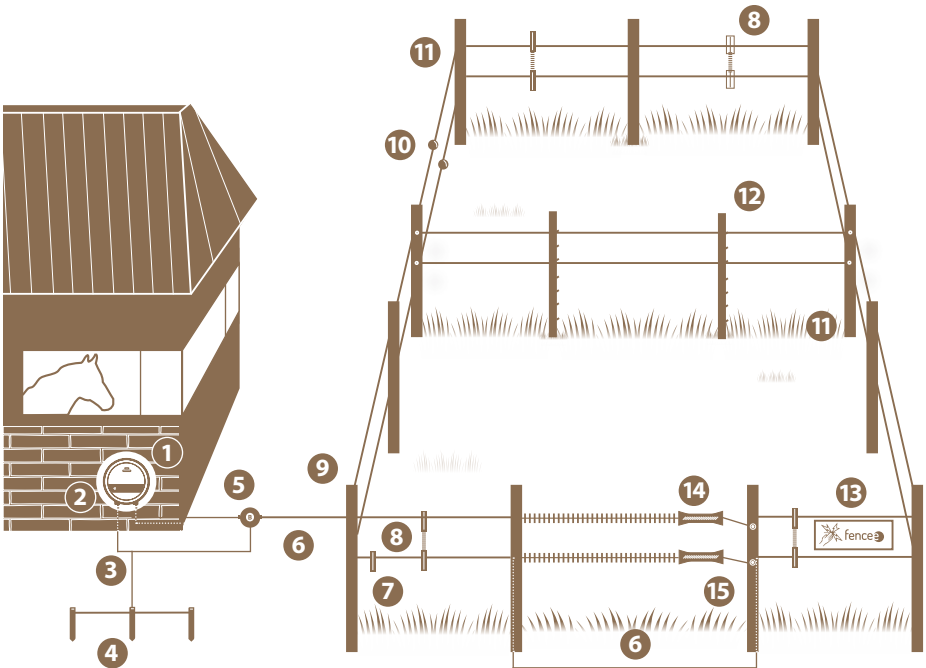

1	Energizer fence
2	ON/OFF button
3	Earthing cable
4	Anticorrosive earthing rod
5	Lightning diverter

6	High-voltage connecting cable
7	Conductor
8	Line connector
9	Fixed post
10	Tensioner

11	Insulators
12	Flexible post
13	Warning sign
14	Gate
15	Insulator of gate

5. INTRODUCTION

Powerful energizers **power energy PE** are suitable for long and densely overgrown fence systems, where it is essential to ensure maximum efficiency and reliability. Owing to their construction and performance, they are able to ensure sufficient high voltage even densely overgrown fence systems and are thus very reliable in protection against predators. The integrated microprocessor fully controls the operation and ensures optimal performance taking into account the condition of the fence system and the current situation. Energizers **power energy PE** may be powered from 230 V mains.

The fence load is continuously measured during the fence systems operation. The energizers **power energy PE** power output is then automatically adjusted to keep the required output voltage in the widest possible load range. This control significantly aids in saving energy when using quality fence system with a low load. It also optimises energy consumption to maintain adequately high fence system voltage, which is, for example, overgrown with grass (high load).

LED indicator lights on the front of the energizer show the power supply status and also signal any potential faults on the fence.

5.1. List of main advantages



Power output 5 J



Powerful transformer



LED indication



ON / OFF button



High voltage 10 000 V



Protection against predators

Graphic presentation of the power performance of the power energy PE transformer

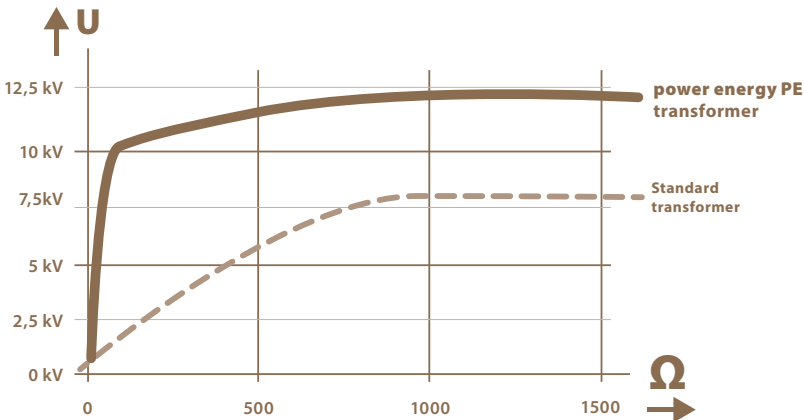

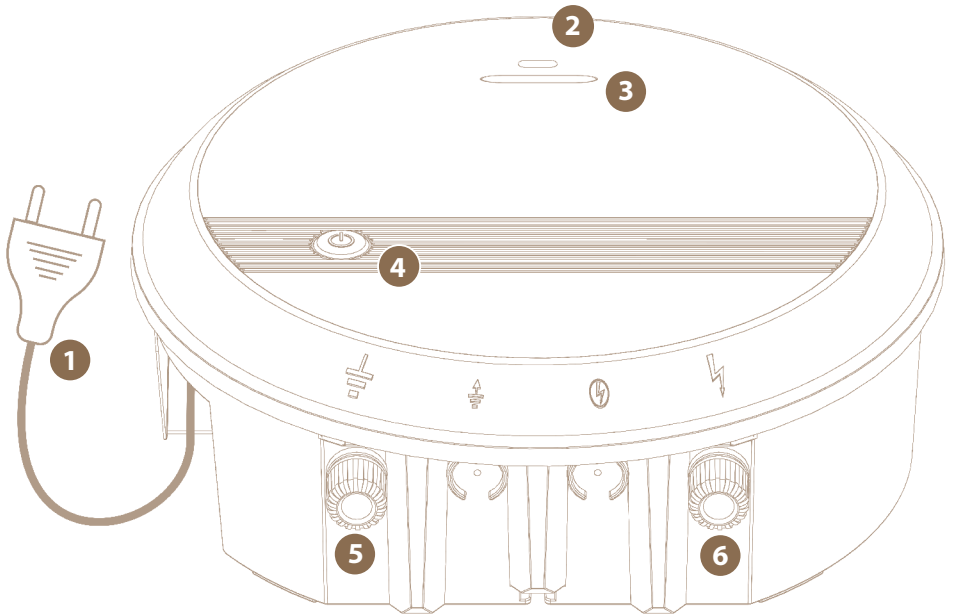

6. PRODUCT DESCRIPTION



1	Power supply connector
2	LED control of operation of energizer and status indication
3	LED control of function
4	ON / OFF switch button
5	Earthing (black)
6	Connection to fence system (red)

Explanations of symbols shown on energizer

-  Earthing connection. Connect this connection to your earthing system.
-  Fence output with full voltage. Connect this connection to your fence system.

7. READY TO USE

Choose a place suitable for installation of energizer.

- Where you can achieve a good earthing.
- Which is distant enough from children and animals.
- Where energizer is well accessible.
- Where permanent water stream is avoided.

To mount energizer on wall, use attached screws, on which you can hang the energizer easily.

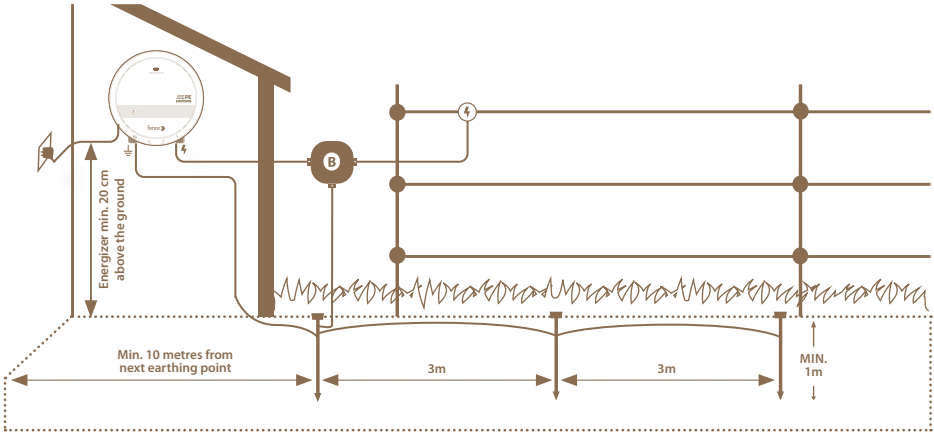

Assembly of energizer by using DIN rail

Energizer can be easily and practically mounted by using DIN rail and mounting bracket. Set for assembly on DIN rail can be ordered as separate accessories.

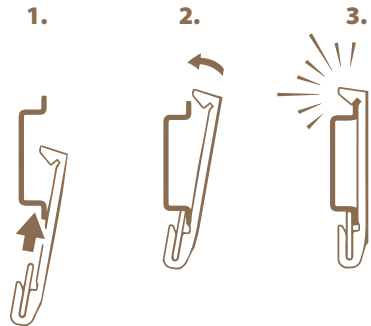
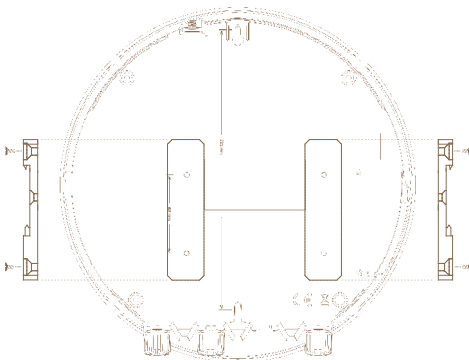



- Energizers must be installed in a dry place.
- Never put energizer on ground – in moist or wet environment.
- Fasten energizer by means of hanging screw or DIN rail with mounting bracket in vertical position – at least 20 cm above ground.
- Never expose energizer to continuous water stream.

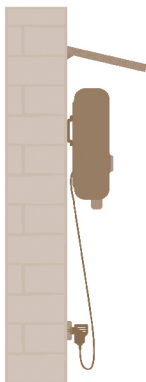

**VERTICAL ON THE WALL
IDEALLY WITH A CANOPY**

We recommend mounting on
DIN rail 80 mm (Art.No. 8043)

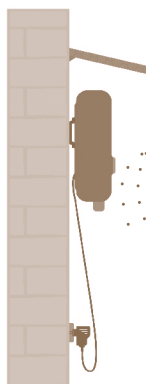

**NEVER EXPOSE TO A
CONTINUOUS STREAM
OF WATER!**

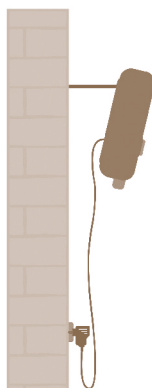

**NEGATIVE
ANGLE**



ON THE GROUND - IN A PUDDLE



ON THE GROUND - UPSIDE DOWN



EARTHING

Correct earthing is very important because total function of the fence system is dependent on it!

Beat earthing rod with corrosion protection into ground completely at place with maximum and permanent humidity. On dry pieces of land or in case of soils with lower electric conductivity, use one or several supplementary earthing rods (with length of minimum of 1 m) and place them at distance of approximately 3 meters from each other.

Exceptions are fence system powered by battery energizer or working with low output. Here minimum length of earthing rod of 50 cm is recommended.

Distance of at least 10 meters must be between earthing rod of the fence system and another earthing system, for example earthing of a house, protective earthing of electric supply system or earthing of violation alarm.

Do not connect the energizer to already existing earthing or to the the earthing of another energizer. Each energizer must have its own earthing.

Connection of the output terminals

⏏ Connect the **black earthing clip** with the earthing cable to the earthing rod.

⚡ Connect the **red clip** with the connecting cable to the fence.

8. CONTROL

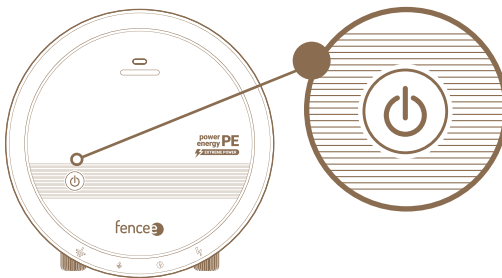

ON / OFF and power output switching push button

For basic control is used large control push ON/OFF button.

This button can be used to turn the energizer on and off.



The energizer remembers its last status and reactivates in it. Therefore, the use of a switching or time socket is possible.

9. EXPLANATION OF LED INDICATING LIGHTS

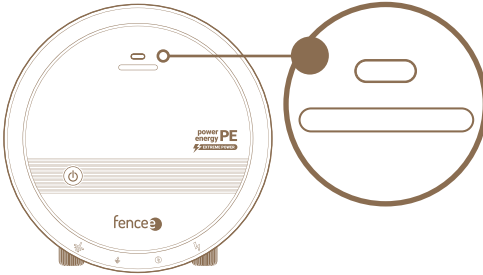

LED control of operation (top):

- **Permanent burning**
energizer on, powered from 230 V mains

LED control of function (bottom):

- **Blinking in the pulse interval**

COLOR:

- **Green** - common operation
- **Red** It lights up when voltage on fence drops below 3 kV.

10. SAFETY GUIDELINES

Install and operate the electric fence systems in such a way that they do not pose the risk of electric shock to humans, animals or disturb the environment.

Avoid using the electric fence systems that could trap animals or people.

One electric fence system must not be powered by two or more energizers or by independent power supply devices designated for electric fence systems of the same equipment.

When operating two or more different electric fence systems and if they are powered by different energizers, the minimum distance between the electric fences must be 2.5 m. Use electrically non-conductive material if this distance is required to be smaller.

Do not use barbed or razor wire or any other types of sharp-edged wire to install the electric fence system.

Non-conductive additional fencing in which barbed or razor wire is used must be at least 150 mm from the electric fence system wire and must be earthed at regular intervals.

All electric fence system sections installed along the public roads must be marked with warning signs attached to poles or fences at regular intervals and visible from the road.

Warning sign

- It is of yellow colour with minimum dimensions of 100 × 200 mm
- It is either standard warning sign or contains the following Inscription on both sides: **WARNING!** ELECTRIC FENCE
- Letters must be at least 25 mm high and indelible
- One warning sign is included in the package contents



Power supply and connecting cables

- Cables that are rated for voltages higher than 1 kV and are located in buildings must be effectively insulated from the building's earthing features. This may be achieved by using insulated high-voltage cables or by leaving appropriate distance between the cable and the building frame. Do not use standard electrical cables

Power supply and connecting cables

- Cables that are laid in the ground (soil) must be protected by solid insulator pipes or use insulated high-voltage cables designed for this purpose. Make sure that the cables will not be damaged by, for example animal hooves or tractor wheels, which can sink into the ground. Do not use standard electrical cables.
- Cables must not be placed in pipes together with other circuit, communication or data cables.

Supply and connecting leads and electric line of fence system:

- Shall not cross above overhead power or communication lines. Crossings with overhead power lines shall be avoided wherever possible. If such a crossing cannot be avoided it shall be made underneath the power line and as nearly as possible at right angles to it.
- If are installed near an overhead power line, the clearances shall not be less than those shown.

Power line voltage	Clearance
≤ 1000 V	3 metres
> 1000 ≤ 33000 V	4 metres
> 33000 V	8 metres

- If are installed near an overhead power line, their height above the ground shall not exceed 3 m. This height applies to either side of the orthogonal projection of the outer most conductors of the power line on the ground surface, for a distance of:
 - 2 m for power lines operating at a nominal voltage not exceeding 1000 V
 - 15 m for power lines operating at a nominal voltage exceeding 1000 V
- Being nearby telephone line or telephone cable, must be conducted at a distance of minimum of 2 metres.

Electric animal fences intended for deterring birds household pet containment or training animals such as cows need only be supplied from low output energizers to obtain satisfactory and safe performance.

In electrical animal fences intended for deterring birds from roosting on buildings no fence wire shall be grounded if the fence wires are not connected to metal parts. If one wire is connected with a metal part (ie a gutter) or a metal structure of the building these metal parts must be grounded. A warning sign shall be fitted to every point where persons may gain ready access to the conductors.

Where an electric animal fence crosses a public pathway, a non-electrified gate shall be incorporated in the electric animal fence at that point or a crossing by means of stiles shall be provided. At any such crossing, the adjacent electrified wires shall carry warning signs.

Avoid direct contact with fencing, especially with head, neck or upper part of body. Do not creep through the fencing or over it. For passing the fence system, use a gate or another point in installation designed for this purpose.

Overvoltage protective equipment – lightning diverter

To prevent from damages caused by lightning, we recommend leading a circuit of fence system near to building via overvoltage protective equipment – lightning diverter fastened to outer masonry of the building by means of non-combustible materials before its connecting to energizer. This applied also for combined energizers, if they are used together with a network adapter.

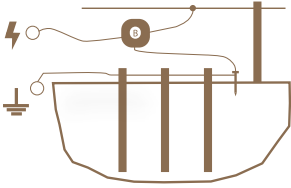

Overvoltage caused by storm can cause insulation of electric fence system. In such a case, network voltage can get into electric fence system, and serious danger to people or animals can occur.

Generally, we recommend connecting network powered electric fence system only to such supply networks that are protected with earth-leakage circuit breaker with maximum actuating current of 30 mA. In addition to that, correct installation of energizer with auxiliary discharger and choking coil is necessary, as described within these instructions. It is suitable to disconnect network supplied electric fence system from network as well as from fencing (if possible) during storm.

If a network with earth-leakage circuit-breaker was not used for purposes of supplying energizer, and the energizer was connected to the fence system or the network during storm, it is necessary to check and test it before putting it into operation again. For this purpose, connection to network with earth-leakage circuit-breaker must be available. For purposes of testing, connect earthing output of energizer to protective conductor of the supply network and connect pin to power socket protected with earth-leakage circuit-breaker then. If energizer beats correctly and does not show any deviations from normal operation subsequently, it can be connected to fence system again. If the earth-leakage circuit-breaker however falls out when energizer is connected, you must not use it and it must be repaired professionally.

If connecting lines of this energizer are damaged, they must be replaced by manufacturer or authorized service or another qualified person so that possibility of danger is excluded. Service and repairs of these energizers must be performed by authorized persons only! Each user of electric fence system is responsible for its operation and should perform regular checks of energizer and fence system at least once a day, depending on operating conditions!

Procedure of checking:

- Visual control of energizer and fence system
- Measuring of minimum voltage of 2500 V in every place of the fence system

If installation is performed inside a building, energizer may not be operated in a room with increased risk of fire in any case (barn, shed, cattle shed). In addition to that, no combustible materials may be stored near to fence system and connectors of energizer. Installation of energizer must be made on a fire-resistant surface.

For stable using, use only energizers designed for that purpose!

Do not connect battery or accumulator energizers to electric power network or devices being connected to network voltage, except for sources determined to that by the manufacturer, in any case. This energizer may not be used by persons (including children) who have limited physical, perceptive or mental abilities or do not possess sufficient experiences and knowledge, when they are not under supervision or are not trained for operating energizer by persons who are responsible for their safety. Children should be under supervision so that there is not chance that they play with the energizer.

Ensure that all connected network supplied auxiliary circuits have at least the same protection class as energizer.

11. TROUBLESHOOTING

In case the energizer is not working properly, try to solve it according to the following table.

Cause	Fault removal
Energizer does not work?	The energizer is either manually switched off, then switched on. If it cannot be switched on, then disconnect it from the fence system, plug it into the mains using an adapter and then switch the energizer again. If the blue or purple LED is on, then the device is fine. If it is red, then the points see below. Otherwise, the device is damaged (contact the seller) During using battery and battery operated devices, observe the correct connection of the poles.
Red blinking on the LED control	The voltage on the fence has dropped below 3 kV - it is necessary to check the fence and remove all voltage leaks (growth, bad insulators,...)
Lead-in or short circuit of supply lines of the fence system.	Do not use conventional cables for supply lines. Highvoltage cable is recommended.
Conductor has adverse properties (thin diameter, high resistance).	Use high-quality conductor with low resistance and larger diameter. Ensure high-quality correct connection of conductors.
Low-quality earthing, too short earth rod, corrosion, dry soil.	Add next rod, moisten.
Lead-in via growth near fence system.	Remove the growth (mow it).
Conductor on ground (for example break, insufficient mechanical tension).	Repair fencing, use special connectors, stretch conductor.
Too long fence system. Was correct accessories used for given purpose?	Use accessories suitable for given length of fence system and for animals – in case of need, consult specialized salesman.
Insulator pierces, losses occur.	Replace defective and weather-worn insulators.
Conductor is connected via knot, insufficient connection.	Use relevant special connectors for the conductor.

12. GUARANTEE

In addition to a guarantee requested by law, we provide you with a guarantee in accordance with below listed conditions:

- Guarantee period begins on the day of its purchase. Guarantee claims are acknowledged explicitly pursuant to submission of bill or cash voucher. Guarantee repair is free of charge, or we reserve the right to deliver a device of the same value.
- Guarantee is valid in case of correct use in accordance with the instructions for use. It expires in case of interferences by unauthorized persons and in case of using spare parts of foreign origin.
- All deficiencies resulting from material defects or manufacturing defects shall be removed in manufacturer's discretion by repairing or free-of-charge replacement of the energizer.
- In case of delivering spare parts or repairing, original guarantee period is not prolonged.
- Guarantee period and address of guarantee provider can be found in attached instructions for use of given type of energizer.
- Accumulators or batteries of any type, damages due to overvoltage (caused by lightning among others) and damages due to spill-over of accumulator acid are not included in the guarantee.

This energizer is provided with guarantee period of 3 years according to our conditions for guarantee! Safety instructions, earthing, putting into operation, care of batteries and accumulator, conditions for guarantee and possible fault sources can be found in attached instructions for use!

13. TECHNICAL PARAMETERS

	power energy PE60
POWER SUPPLY AND CONSUMPTION	~ 230 V / 6 W
INPUT ENERGY	5,5 J
OUTPUT ENERGY	5 J
OUTPUT VOLTAGE	12500 V
OUTPUT VOLTAGE 500 Ω	10000 V
ON / OFF	✓
LED ON / OFF	✓
LED IMPULS	✓
LED LOW BATTERY VOLTAGE	✓
LED ERROR CHECK	✓
EARTHING 1 m	5×
EL. FENCE NETTING	25×
DIN RAIL	✓
DIAMETER	290 × 108 mm
WEIGHT	3650 g



fencee

27032023

fencee
Electric fencing

Stamp and signature of seller:

VNT electronics s.r.o.
Dvorská 605, 563 01 Lanškroun
Czech Republic
info@fencee.eu
+420 730 893 828



f fencee.cz @ fenceeczech

www.fencee.eu
www.fenceefarm.com
www.fenceecloud.com